

R19IW3S-MLA3FP

19" Intel® Core™ i5-8265U Defence Console Rack Panel PC

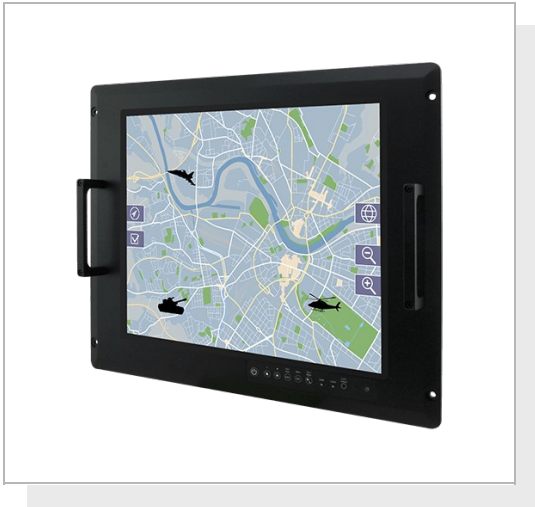

KEY FEATURES

- Intel® Core™ i5-8265U 1.6GHz Processor
- Anti-Corrosion Housing / Fanless
- Projective Touch
- Compliant with MIL-STD-810G/F , MIL-STD-461E/F
- Flush Rack / Rack Mount Mechanical Design (8U)
- Convenient On-Screen Display Controls
- AC 110~240 V Power input default
- Isolation DC 9~36 V Power input (Optional)
- Built-in Light Sensor for auto brightness control



SPECIFICATIONS

Display	
Resolution	1280x1024
Contrast Ratio	1000:1
View Angles	85,85,80,80
Touch / Glass	Projected Capacitive Multi Touch Screen PCAP with With ITO Film (Optional)
Size	19 inches
Panel Brightness	350 nits
Active Area	376.32x301.06 mm
System Specification	
Processor	Intel Core i5-8265U 1.6GHz (up to 3.9GHz)
Memory	1 x SO-DIMM, DDR4 2400 MHz, 4GB 8GB (Optional) 16GB (Optional) 32GB (Optional)
Storage	1 x M.2 2242 B-key SSD 64GB up to 512GB (Optional)
Ethernet controller	Intel® Ethernet Controller I210-AT + Intel® Ethernet Connection I219-LM
Operating System	Windows 10 IoT Enterprise (Optional)
Environment	
Operating Humidity	10% to 95% RH
Operating Temperature	-20°C~60°C
Storage Temperature	-30°C~70°C
Compliance	
MIL-STD 461E/F	RE101 / RE102 CE101 / CE102 with EMI Glass / Touch(Optional) RS101 / RS 103 CS101 / CS 106 / CS 109 / CS 114 / CS 115 / CS 116
MIL-STD 810F/G	Vibration Method 514.5 Humidity Method 507.4 Transit Drop Method516.5
Certification	
Certification	CE, FCC
Accessory	
Accessory	1 x Manual(Hardcopy) 1 x Driver CD 1 x Power Cord (MIL-DTL-38999/1)
Mechanical	

Dimension	482.6 x 399.3 x 79.6 mm	Mounting	Rack Mount/ VESA Mount
Enclosure	Metal Housing with Aluminum Bezel	Cooling System	Fanless Design
IO Ports			
USB Port	2 x USB 3.2 Gen 1	Serial Port	1 x RS232(Default)/422/485
Video	1 x HDMI (Optional)	LAN	2 x RJ-45
Power			
Power Rating	AC 100~240V, Universal, ±10% DC 9~36V, ±10% (Optional)		
Control			
Button	8 Key OSD Control Pad: Power, Brightness DOWN, Brightness UP, Night, Day, Auto / Manual, Reset, Lock		

DIMENSIONS UNIT:MM

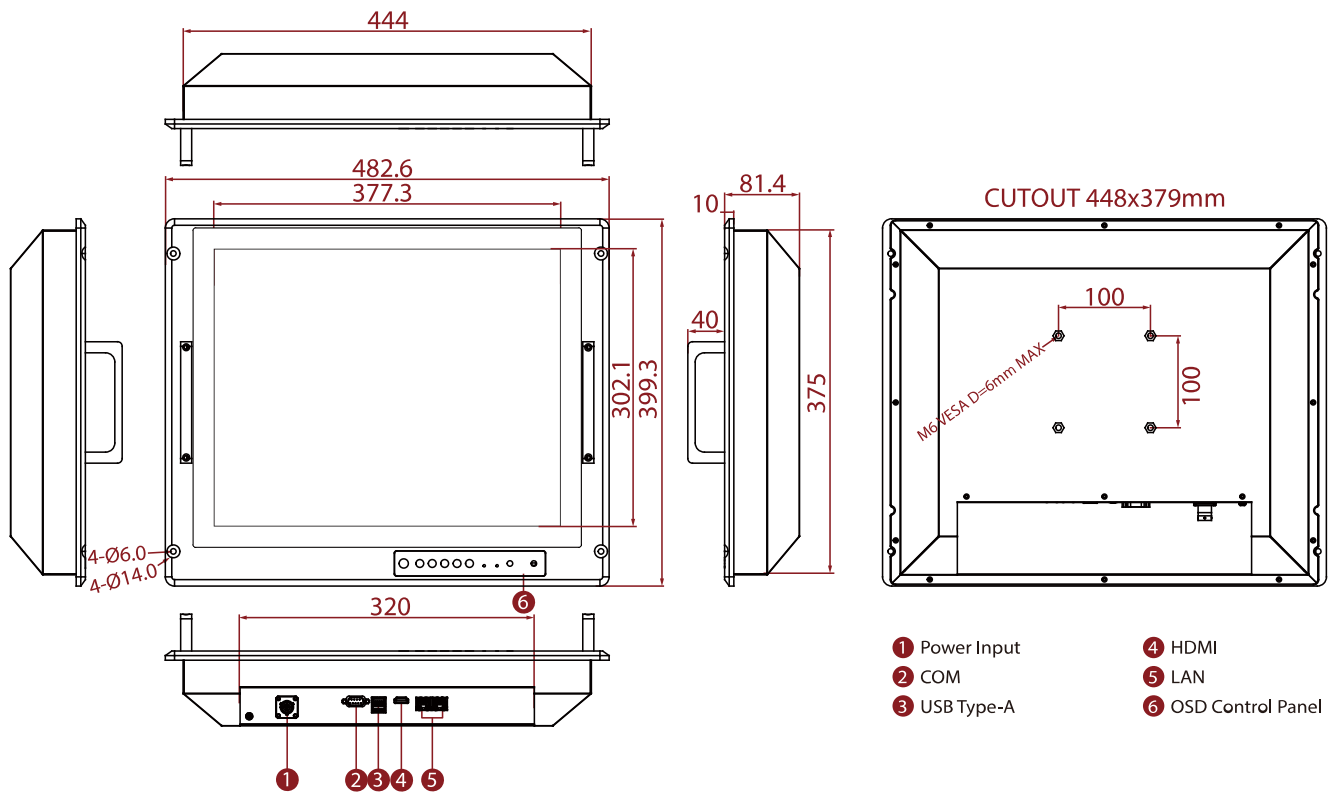

NOTE

1. The product shown in this datasheet is a standard model. For diagrams that contain customized or optional I/O, please contact the Winmate Sales Team for more information.