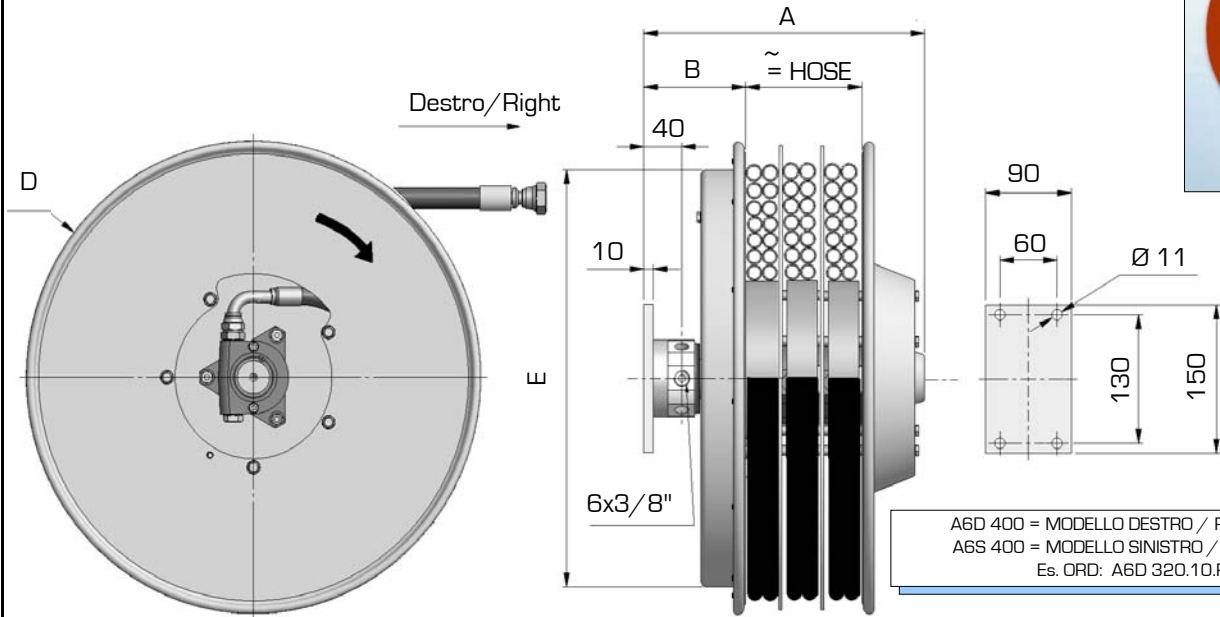
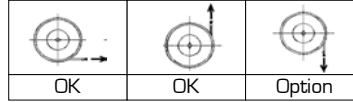

141.1
MAX
40 l/min

W. P. 300 bar
Option 400 bar

MAX HOSE SPEED
30 m/min

A6D 400 = MODELLO DESTRO / RIGHT MODEL
A6S 400 = MODELLO SINISTRO / LEFT MODEL
Es. ORD: A6D 320.10.R7

Modello destro Right model	A	B	D	E	Con tubo - with hose R7 - R8 - B1 - B2		
					Ø	Lungh.totale	Lung.utile
						Total length	Usable length
mm					m		
A6D295.06.XX	277	92	295	272	1/4"	4,0	3,7
A6D295.08.XX					5/16"	3,2	2,9
A6D295.10.XX					3/8"	3,0	2,7
A6D320.06.XX	277	92	325	272	1/4"	5,0	4,7
A6D320.08.XX					5/16"	4,0	3,7
A6D320.10.XX					3/8"	3,5	3,2
A6D340.06.XX	277	92	340	272	1/4"	6,0	5,7
A6D340.08.XX					5/16"	5,0	4,7
A6D340.10.XX					3/8"	4,5	4,2
A6D370.06.XX	277	92	370	322	1/4"	7,0	6,7
A6D370.08.XX					5/16"	6,0	5,7
A6D370.10.XX					3/8"	5,5	5,2
A6D400.06.XX	277	92	400	322	1/4"	7,5	7,2
A6D400.08.XX					5/16"	7,0	6,7
A6D400.10.XX					3/8"	6,5	6,2
A6D420.06.XX	277	92	420	322	1/4"	8,5	8,2
A6D420.08.XX					5/16"	8,0	7,7
A6D420.10.XX					3/8"	7,5	7,2